



VAT Pasteurization Combination Electronic Control Package

Field Setup Guide

Revision 5.1 6-21-10

Document 1162

Anderson Instrument Co., Inc.

156 Auriesville Rd. ~ Fultonville, NY 12072

Table of Contents

- 1. REGULATORY CHECKLIST 3**
- 2. INTRODUCTION 4**
- 3. REGULATORY COMPLIANCE OF HARDWARE 5**
 - 3.1. CHART RECORDER IDENTIFICATION AND COMPLIANCE 5
 - 3.2. CHART PLATE HEALTH AUTHORITY SEAL 7
 - 3.3. SENSOR IDENTIFICATION AND COMPLIANCE 8
 - 3.4. SENSOR HEALTH AUTHORITY SEAL 9
- 4. PROGRAM LOCKOUT OPERATION 10**
 - 4.1. KEYPAD 10
 - 4.2. SECURITY MODE SELECTION SHUNT 10
 - 4.3. LOCKING ACCESS – RUN MODE 11
 - 4.4. UNLOCKING ACCESS – PROGRAM MODE 13
- 5. WIRING DESCRIPTION AND VERIFICATION 15**
- 6. PASTEURIZED MILK ORDINANCE (PMO) APPENDIX I TESTING 16**
 - 6.1. PMO TESTING QUICK REFERENCE 16
 - 6.2. TEST 1 - INDICATING THERMOMETERS – TEMPERATURE ACCURACY 17
 - 6.3. TEST 3 - RECORDING THERMOMETERS – TIME ACCURACY 19
 - 6.4. TEST 4 - RECORDING THERMOMETERS – CHECK AGAINST INDICATING THERMOMETER 20
 - 6.5. TEST 15 - ELECTRO MAGNETIC INTERFERENCE 24
- 7. TROUBLESHOOTING 26**
 - 7.1. RECORDING PEN TO DISPLAY CALIBRATION 26
 - 7.2. RECORDING THERMOMETER AND INDICATING THERMOMETER TEMPERATURES DIFFER 30

DATE OF UPDATE	DESCRIPTION	NEW DOCUMENT REVISION
2-24-10	RELEASE OF MANUAL	5.0
6-21-10	UPDATE SEAL REQUIREMENTS	5.1

1. Regulatory Checklist

This section has been provided as a checklist for Regulatory to utilize during an initial startup of an Electronic VAT Controls Package, or as a reference during ninety day checks and troubleshooting.

_____ 1. New installations – be sure to review Section 2 covering system introduction. Verify proper chart range has been supplied that meets requirements for pasteurization temperature.

_____ 2. If working on an existing system, the chart plate seal must be broken, and the “Security Mode Shunt Jumper” must be moved to program position. Refer to Section 4 for details. Be sure to “re-seal” after testing is complete.

_____ 3. If working on a new system, Inspector should first verify compliance of unit and wiring. Refer to Section 3 and 5 for details. Customer should demonstrate proper wiring as shown in section 5. Pay careful attention to the power for each temperature probe – NO EXTERNAL power supplies should be present in the panel or system. Be sure system is wired exactly as shown.

_____ 4. Verify that recording pens match recorder display within +/- .5 deg F. It is understood that the onboard “Chart Recorder” displays are NOT the Regulatory reference, but this is a good opportunity to synchronize both the pen and the display for operator convenience. The PEN itself will be used for Regulatory testing. If an adjustment is required, refer to Section 7 for proper procedures.

_____ 5. Review Pasteurized Milk Ordinance (PMO) testing found in Section 6. Procedures that differ from those printed in the PMO are outlined in this section.

_____ 6. When testing is complete, be sure to properly seal unit. The “Chart Plate Seal, Product Probe Seal and Airspace Probe Seal” examples are shown in Section 3. The “Security Mode Selection Shunt” setup procedure is shown in Section 4, and involves turning “off” all critical menus that have been enabled.

2. Introduction

The Electronic VAT Combination Indicating / Recording Thermometer package first starts with the use of a dual pen circular chart recorder. The time proven AJ-300 series recorder is provided. This unit offers NEMA 4X wash-down protection in an enclosure that is easily wall or panel mounted. Front mounted displays provide convenience to the operator for monitoring the process.

Next, two dual element all stainless steel temperature probes are provided. One probe is used for monitoring airspace temperature, and the other for monitoring product temperature. Each probe has an integral display, easily viewable by the operator. It is this display that replaces the traditional mercury in glass thermometer. One temperature element of each of the probes directly wires to the AJ recorder. This provides recording for the hot product, recorder pen one, and the airspace, recorder pen two. The remaining temperature element of each probe provides a signal directly to the integral display. This display functions as the airspace and product reference temperatures in each of the respective probes.

As in the traditional process, the operator simply views the temperature from the display on each of the probes, and matches to the recording trace on the recorder. As the temperatures on the reference probes are now digital, difficulty in reading mercury in glass thermometer scales is also eliminated.

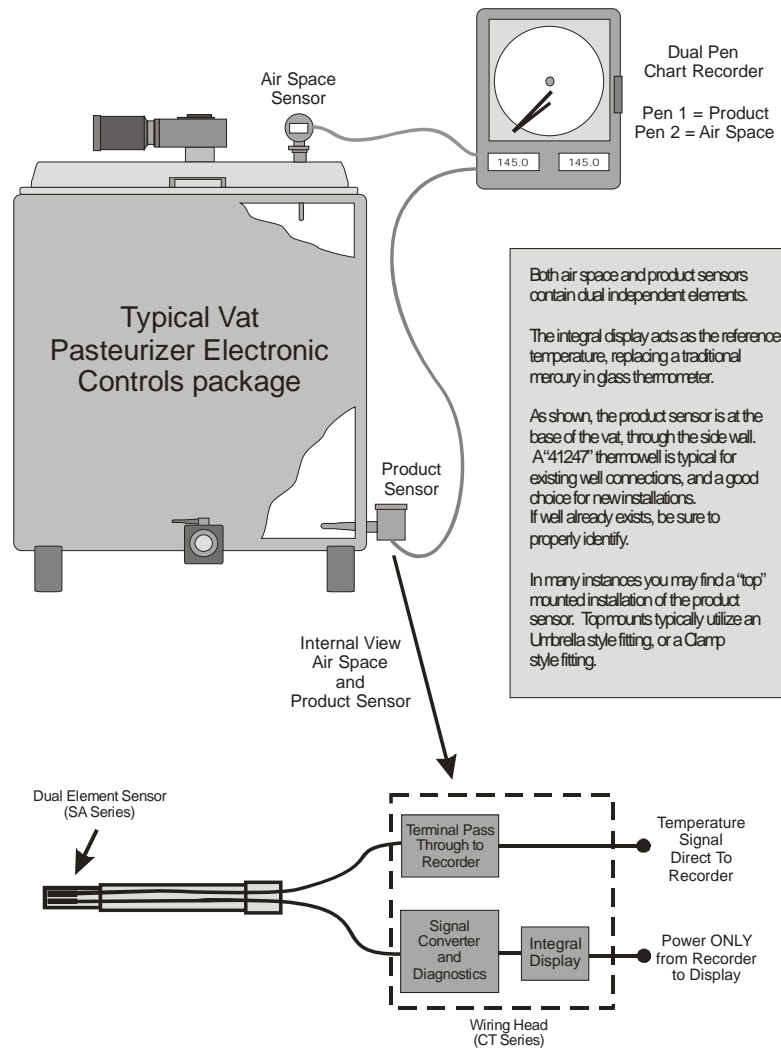

3. Regulatory Compliance of Hardware

The Anderson VAT Control Package has been designed to comply with the latest revision of the Pasteurized Milk Ordinance that allows for Digital Combination Indicating Thermometers on VAT (Batch) Pasteurizers. This section describes specific features and designations that can be used to verify all equipment present in the field is compliant.

3.1. Chart Recorder Identification and Compliance

The Anderson Model AJ-300 series chart recorder has been utilized for this combination package. Mandatory criteria for compliance are as follows:

1. Chart recorder MUST be dual pen, with Pen 1 recording Product, and Pen 2 recording Airspace
2. Paper chart MUST comply with traditional requirements for temperature scale and rotation
3. Chart recorder MUST contain a HARDWARE lockout jumper to prevent modification of program parameters during processing.
4. Chart recorder MUST provide a means to place Health Authority Seal on chart plate to prevent access to wiring and program lockout jumper.
5. Chart recorder MUST provide an integral DC power supply to provide an independent power source for Indicating Thermometer displays located in each sensor. A power supply located remotely in the panel, and not capable of receiving a Health Authority Seal is not permissible.

As the AJ Series Recorder is available in various configurations, the following table and product code matrix have been provided so that a recorder may be verified for compliance in the field. A sticker is located just behind the hinged door illustrating the exact model of the unit. All stickers indicate "AJ-300" series recorders. This designation refers to the generic series of the recorder. You will need to reference the 14 digit matrix number at the bottom of the sticker.

Digit Location	Description	Regulatory Verification
Digit 1	Model Prefix	MUST BE 3
Digit 2	Pen option for Record or Record/Temp Loop Control	MUST BE 1 OR 2
Digit 2	Pen option for Record or Record/Temp Loop Control	MUST BE 1 OR 2
Digit 4	Relay Outputs	NO Regulatory Requirement
Digit 5	Fixed 0	MUST BE 0
Digit 6	Current Outputs	NO Regulatory Requirements
Digit 7	Fixed 1	MUST BE 1
Digit 8	Fixed 0	MUST BE 0
Digit 9	Fixed 0	MUST BE 0
Digit 10	Fixed 0	MUST BE 0
Digit 11	Fixed 2	MUST BE 2
Digit 12	Operating Voltage	NO Regulatory Requirements
Digit 13-14	Fixed 01	MUST BE 01

Model Number of Customer Recorder Supplied = _____

Serial Number of Customer Recorder Supplied = _____

A J 3 **0** **1** **0** **0** **0** **2** **0** **1**

PEN 1 _____
 1 Recorder
 2 Recording Controller

PEN 2 _____
 1 Recorder
 2 Recording Controller *

RELAY OUTPUTS _____
 0 None
 1 One SPST
 2 Two SPST
 4 Four SPST

0 **FIXED CHARACTER** _____

4-20mA ISOLATED OUTPUTS** _____
 0 None
 1 One
 2 Two

TRANSMITTER POWER SUPPLY _____
 1 24 Volt, regulated(standard)

0 **FIXED CHARACTER** _____

0 **FIXED CHARACTER** _____

0 **FIXED CHARACTER** _____

ENCLOSURE _____
 2 Standard Nema 4X

VOLTAGE _____
 1 115V Standard
 2 115/230V

OPTION SUFFIX _____
 01 Sealable Chart Plate

**Must Specify
 Charts with order**

* Pen 2 available as Recording Controller, only if Pen 1 is Recording Controller.
 ** Required for each controller, if modulated output is required.

CHARTS

- 00215307 90-190 12hr (Std °F range)
- 00215303 0-200 24hr (If pasteurization is above 160°F)
- 00215357 30-90 12hr (Std °C range)

PENS

- 60500402 (Red, Pen #1)
- 60500401 (Green, Pen #2)

3.2. Chart Plate Health Authority Seal

Provisions have been provided for placing the Regulatory Wire Seal in the upper right corner of the chart plate. When in place, this seal prevents unauthorized access to not only the internal wiring, but also access to the Security Mode Shunt.

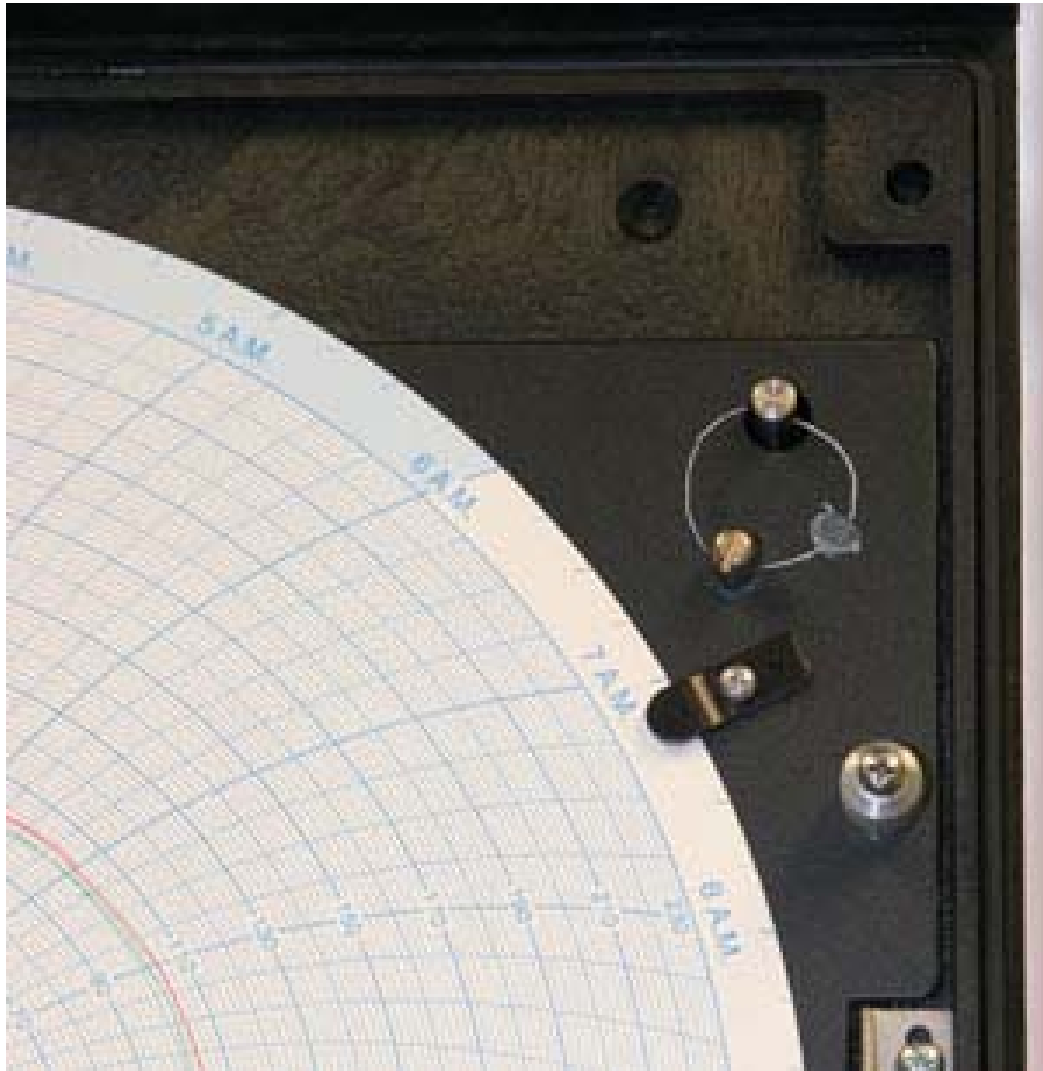

3.3. Sensor Identification and Compliance

You may utilize the matrix shown below to verify features present on the sensors being tested.

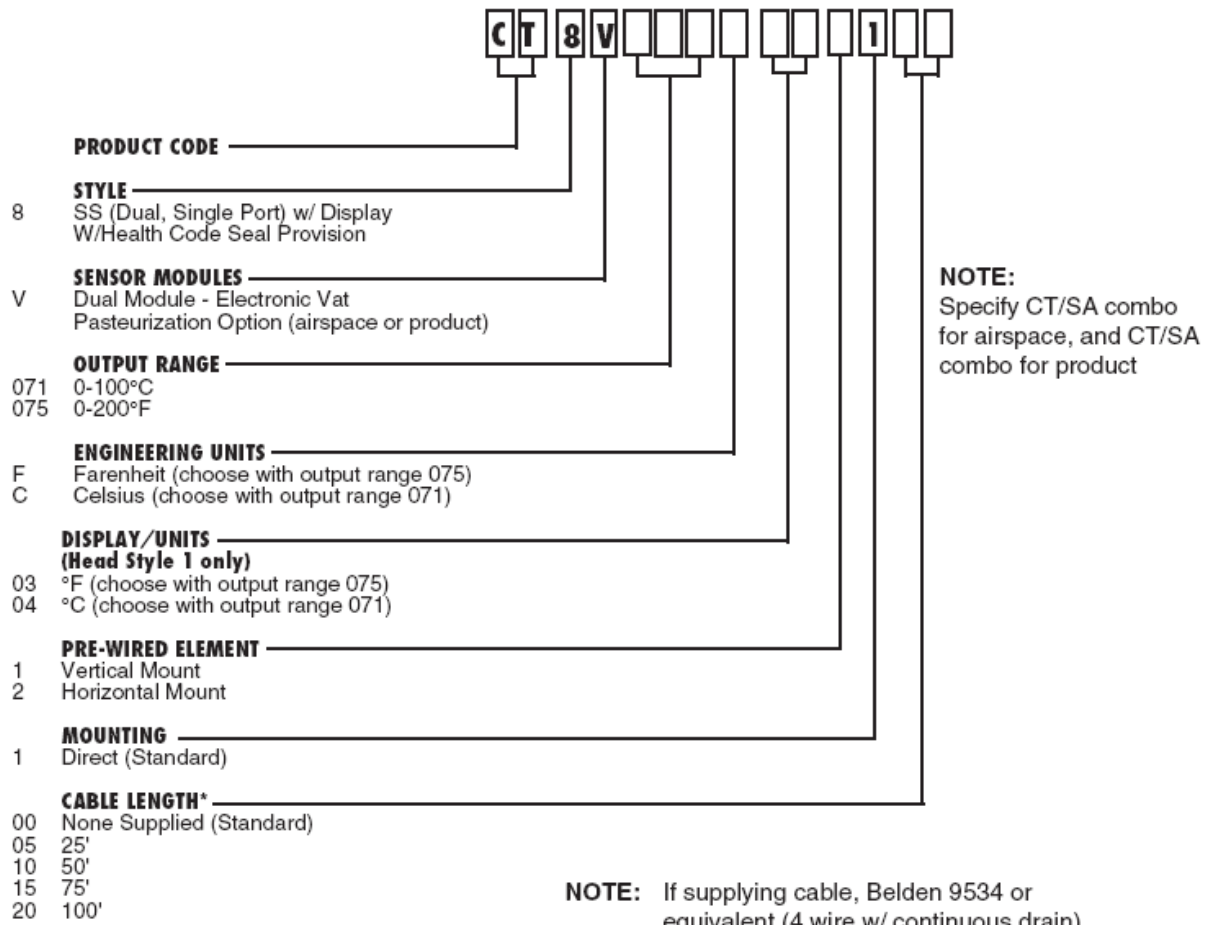

For models not matching the above matrix, it is recommended that the Factory be consulted for verification. In order to meet a customers exact application, a special modification may have been performed at the factory. Sensors of this type may show a model starting with "PM." If this is the case, the base sensor, with modifications, may still comply with the required regulations.

The following matrix illustrates options for the sensing element portion of the probe. As in all cases, be sure to verify proper standards that may apply for tip to cover, and tip to product measurement requirements.

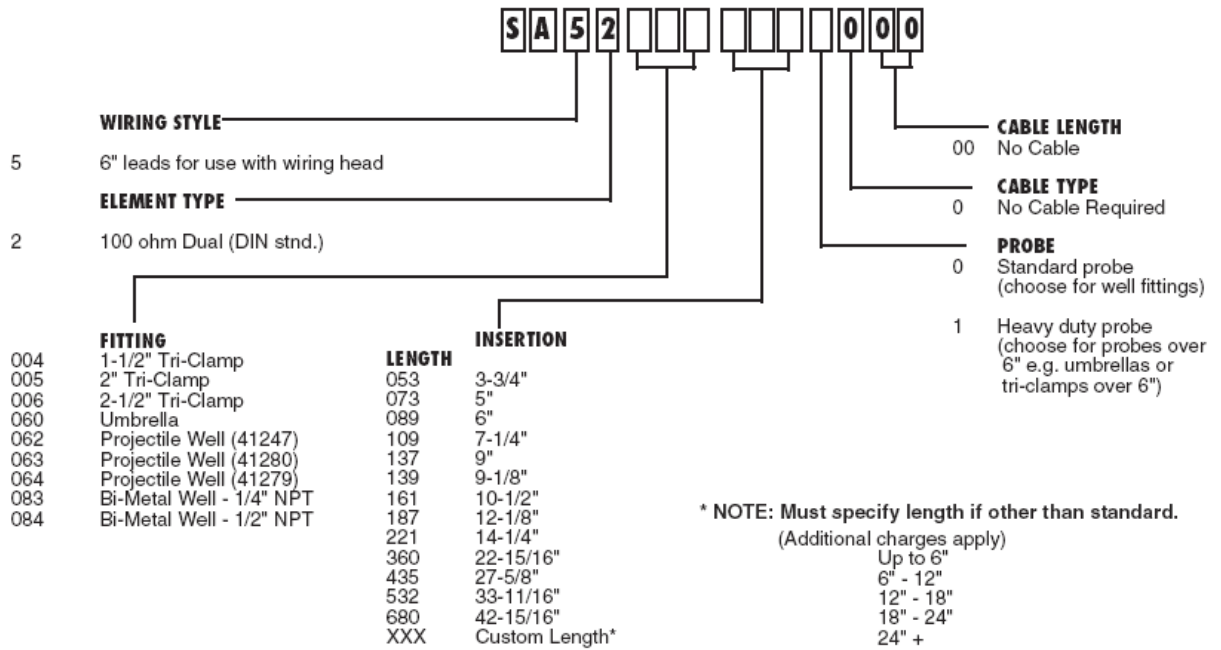

3.4. Sensor Health Authority Seal

Provisions have been provided for placing the Regulatory Wire Seal on the cap of both the Airspace and Product sensors. When in place, this seal prevents unauthorized access to the internal wiring, or adjustment of the sensor output.



4. Program Lockout Operation



NOTE: States will be required to enable the Health Authority Seal “Lock Out” capabilities of the Anderson VAT Pasteurization Electronic Controls Package. To comply, the following must be completed:

- Health Authority seals put in place on Chart Plate as in Section 3.2
- Health Authority Seals put in place on Product as well as Airspace probes as in Section 3.4
- All program functions must be disabled, as shown in Section 4.3

This section outlines the procedures required to Enable and Disable the programming functions of the Recorder.

4.1. Keypad

Located on the front chart plate of the unit is the USER KEYPAD. From here, access to the program parameters can be gained. A description of each of the keys is as follows:





	UP ARROW	Used to move through menus, or increase a value
	DOWN ARROW	Used to move through menus, or decrease a value
	SCROLL	Used to move through menus

4.2. Security Mode Selection Shunt

The AJ Recorder is equipped with a movable “Security Shunt Jumper” to allow toggling between RUN and PROGRAM modes of operation. While in RUN (Center to Top Pin) mode, access is prevented to all system critical parameters. While in PROGRAM (Center to Bottom Pin) mode, full access to all system parameters is allowed.

The following procedure illustrates the steps that must be taken to utilize the system lockout feature.

4.3. LOCKING ACCESS – RUN MODE

1. Simultaneously press the   arrow keys at the same time for approximately ten seconds. The recorder will cycle through various modes - **DO NOT RELEASE until “EnAb” is visible on the display.** Once “EnAb” is visible, release keys to enter Enable menu.
2. All menu options with an on/off option should be set to “off” using the   arrow keys. Press  to step through each of the Enable / Disable options setting as required.

A Model 311 Recorder will have the following options:			
Test Mode	EtSt	on / off	SET TO “OFF”
Calibration Mode	ECAL	on / off	SET TO “OFF”
Program Mode	EPro	on / off	SET TO “OFF”
Alarm Set mode	EASt	on / off	SET TO “OFF”

A Model 312 or 322 Recorder will have the following options:			
Test Mode	EtSt	on / off	SET TO “OFF”
Calibration Mode	ECAL	on / off	SET TO “OFF”
Program Mode	EPro	on / off	SET TO “OFF”
Tune Mode	Etun	on / off	SET TO “OFF”
Manual Mode	ESby	on / off	SET TO “OFF”
Setpoint Select Mode	ESPS	on / off	SET TO “OFF”
Setpoint Change	ESPC	on / off	SET TO “ON”

3. Once changes are complete, press the  arrow key at any of the menu headings. This will exit you from the Enable / Disable menu.
4. On the main motherboard, located behind the chart plate, is a Jumper labeled JU1. It is located directly behind the longest ribbon cables.

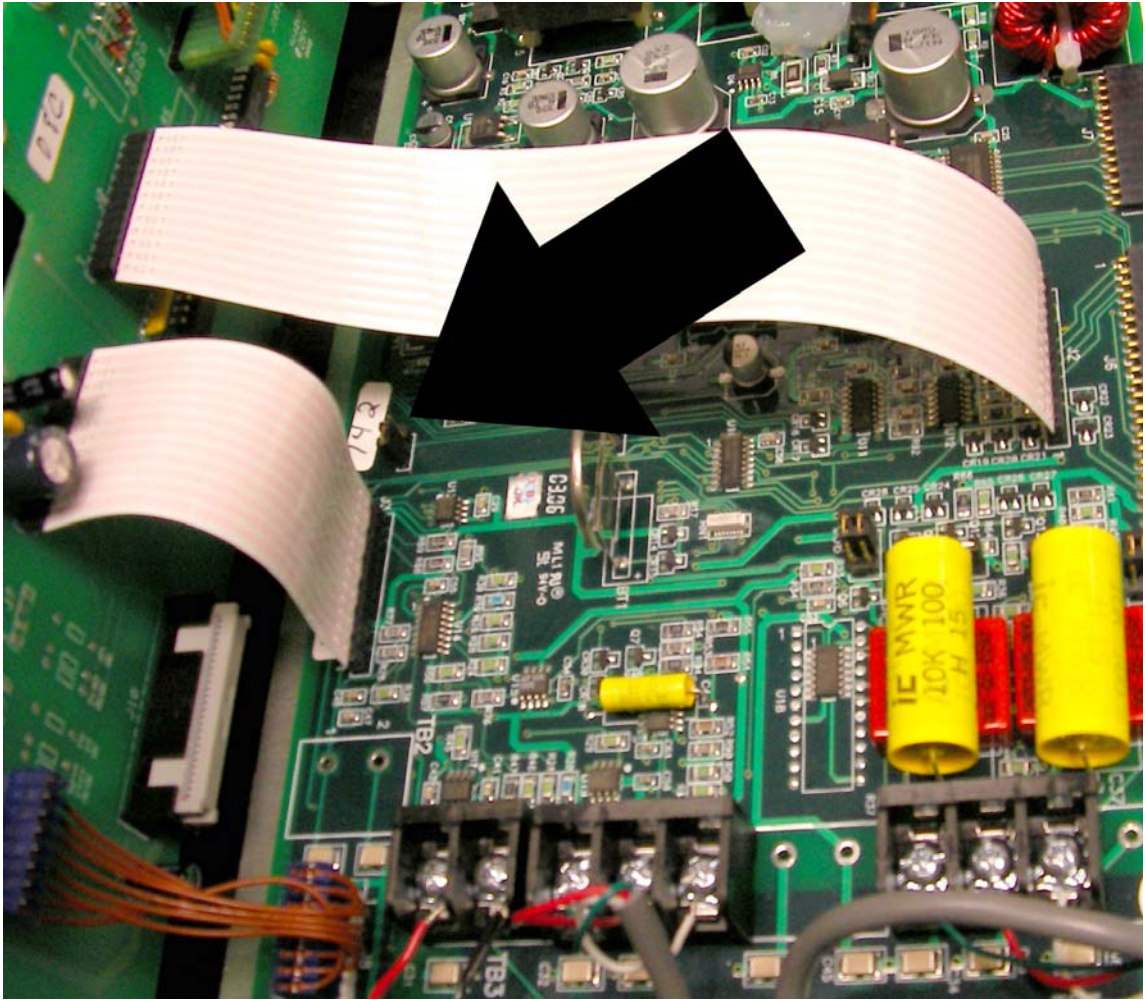

Ju1 Lock Jumper



Unlocked



Locked

5. With the jumper placed in the lock position (Center Pin to Top Pin), access to the enable menu is prevented. By setting all of the enable parameters to the “off” position, access to the program menu is prevented. With a Health Authority seal placed on the chart plate, the resulting combination prevents access to any of the key programming parameters.

4.4. UNLOCKING ACCESS – PROGRAM MODE

1. On the main motherboard, located behind the chart plate, is a Jumper labeled JU1. It is located directly behind the longest ribbon cables.

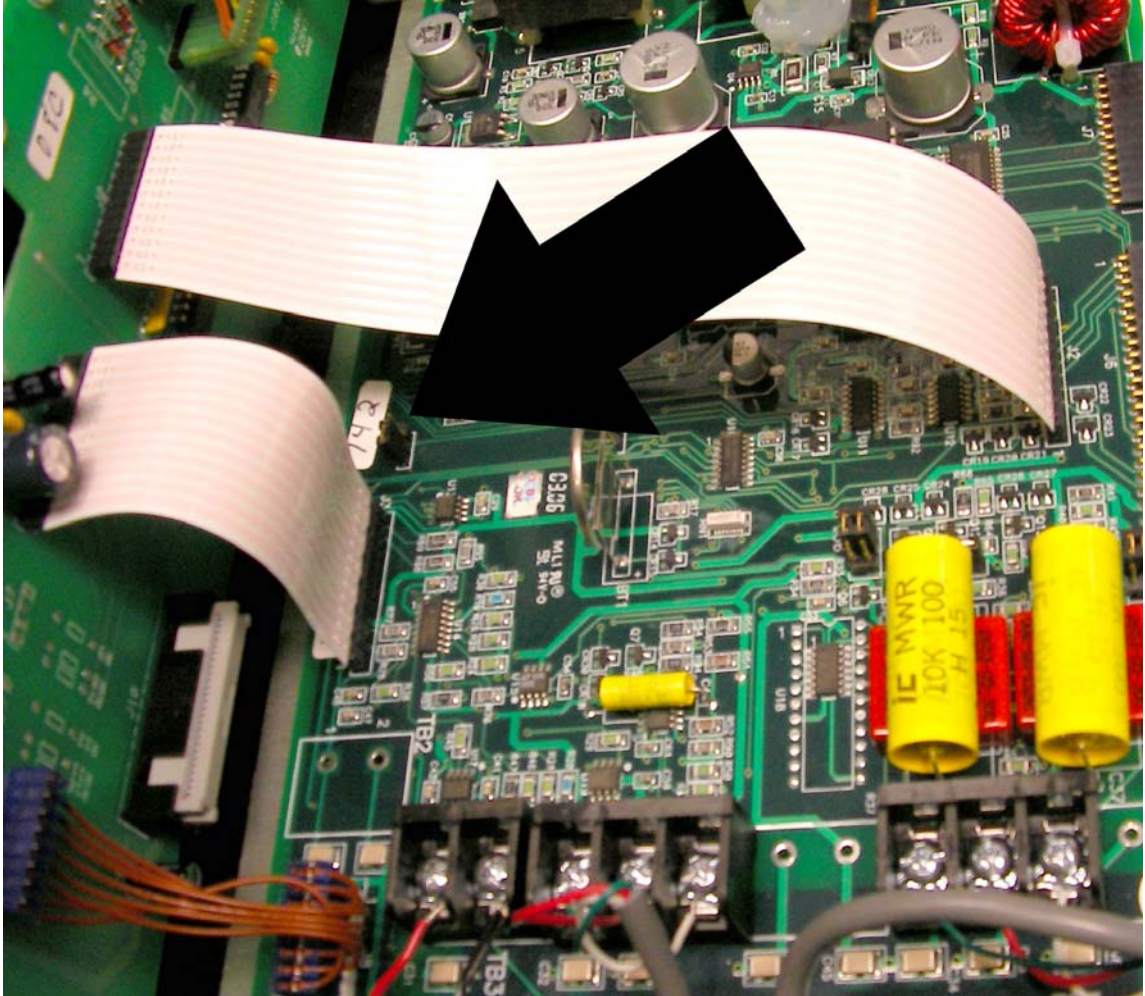

Ju1 Lock Jumper







Unlocked



Locked

2. With the jumper placed in the CENTER TO BOTTOM PINS, the unit is in PROGRAM MODE.

3. Simultaneously press the   arrow keys at the same time for approximately ten seconds. The recorder will cycle through various modes - **DO NOT RELEASE until “EnAb” is visible on the display.** Once “EnAb” is visible, release keys to enter Enable menu.

4. All menu options that require access should be set to “ON” using the   arrow keys. Press  to step through each of the Enable / Disable options setting as required.

A Model 311 Recorder will have the following options:			
Test Mode	EtSt	on / off	SET TO “OFF”
Calibration Mode	ECAL	on / off	SET TO “ON” for calibration
Program Mode	EPro	on / off	SET TO “ON” for program changes
Alarm Set mode	EASt	on / off	SET TO “OFF”

A Model 312 or 322 Recorder will have the following options:			
Test Mode	EtSt	on / off	SET TO “OFF”
Calibration Mode	ECAL	on / off	SET TO “ON” for calibration
Program Mode	EPro	on / off	SET TO “ON” for program changes
Tune Mode	Etun	on / off	SET TO “OFF”
Manual Mode	ESby	on / off	SET TO “OFF”
Setpoint Select Mode	ESPS	on / off	SET TO “OFF”
Setpoint Change	ESPC	on / off	SET TO “ON”

5. Once changes are complete, press the  arrow key at any of the menu headings. This will exit you from the Enable / Disable menu.

5. Wiring Description and Verification

The following diagram illustrates proper wiring of the system.

NOTE: BE SURE TO ALLOW ENOUGH CABLE SO THAT BOTH SENSORS MAY BE REMOVED FROM THE VAT AND PLACED INTO THE SAME TEMPERATURE BATH

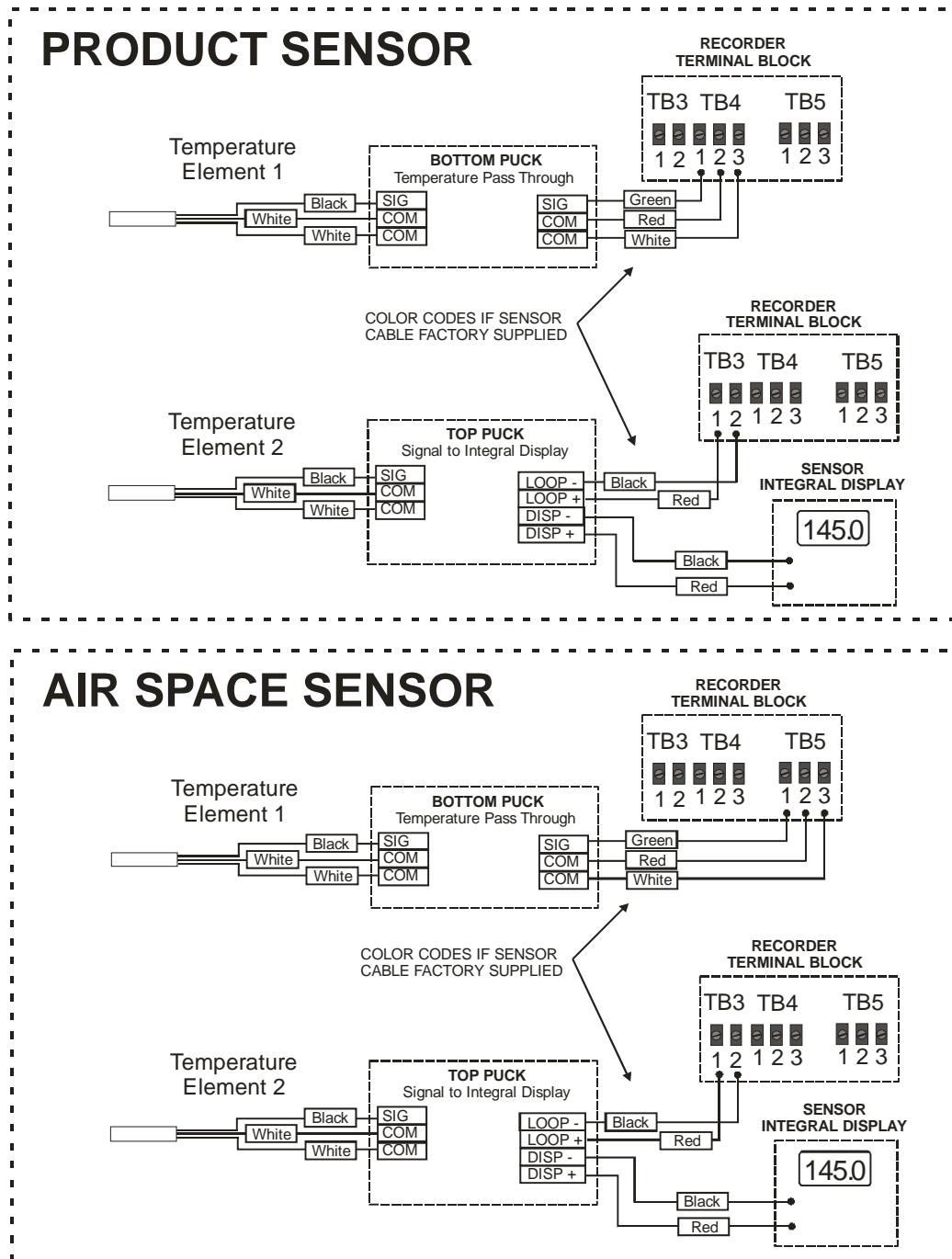

6. Pasteurized Milk Ordinance (PMO) Appendix I Testing

This section will provide specific procedures regarding the completion of the PMO Appendix I tests. Only testing procedures directly related to the VAT Pasteurization Combination Electronic Control Package have been included.

6.1. PMO Testing Quick Reference

Test	Description	Variance From Printed PMO Appendix I Test
1	Indicating Thermometers – Temperature Accuracy	Onboard sensor display used as “Indicating Thermometer” – one present for “Airspace,” and one present for “Product” sensing.
2	Recording Thermometers – Temperature Accuracy	This test is not required for VAT (Batch) Pasteurizers as of the 2009 Pasteurized Milk Ordinance
3	Recording Thermometers – Time Accuracy	No changes to this test – performed as traditionally done on “drag pen” style recorders. Test ONLY Pen 1 – this is the pen that follows time arc
4	Recording Thermometers – Check Against Indicating Thermometer	Recording Pen 1 compared against Onboard display of “Product” sensor, and Recording Pen 2 compared against display of “Airspace” sensor. IF unit is sealed by Regulatory, adjustment of the pen is not permitted by the operator. Refer to this section for additional details.
15	Electro Magnetic Interference	Test documented, but not required as of this document release.

6.2. TEST 1 - Indicating Thermometers – Temperature Accuracy

This test involves comparing the Airspace and Product Indicating Thermometers with the Inspectors lab standard thermometer. Testing is performed using the methods outlined in the Procedures and Corrective Actions section of Appendix I – Test 1.

For reference, text inserted from 2009 revision Pasteurized Milk Ordinance. Any special requirements that have been approved, but may differ from the standard PMO tests, immediately follow.

TEST 1 - INDICATING THERMOMETERS - TEMPERATURE ACCURACY

Reference: Item 16p.(A), (B), (C) and (E)

Application: To all indicating thermometers used for the measurement of milk or milk product temperature during pasteurization or aseptic processing, including airspace thermometers.

Frequency: Upon installation; at least once each three (3) months thereafter; whenever the thermometer has been replaced or the regulatory seal on a digital sensor or a digital control box has been broken.

Criteria: Within $\pm 0.25^{\circ}\text{C}$ ($\pm 0.5^{\circ}\text{F}$) for pasteurization and aseptic processing thermometers and $\pm 0.5^{\circ}\text{C}$ ($\pm 1^{\circ}\text{F}$) for airspace thermometers, in a specified scale range. Provided, that on batch pasteurizers used solely for thirty (30) minute pasteurization of milk or milk products at temperatures above 71°C (160°F), indicating thermometers shall be accurate to within $\pm 0.5^{\circ}\text{C}$ ($\pm 1^{\circ}\text{F}$).

Apparatus:

1. Test thermometer meeting the specifications cited in Section I of this Appendix;
2. Water, oil or other suitable media bath and agitator; and
3. Suitable means of heating the media bath.

Method: Both thermometers exposed to water, oil or other suitable media of uniform temperature. Indicating thermometer reading is compared to the reading of the test thermometer.

Procedure:

1. Prepare a quantity of water, oil or other suitable media in a bath, by raising the temperature of the media to within 2°C (3°F) of the appropriate pasteurization, or airspace temperature, or aseptic processing temperature.
2. Stabilize the bath temperature and agitate rapidly.
3. Continue agitation and insert indicating and test thermometers to indicated immersion point.
4. Compare both thermometer readings at the temperature within the test range.
5. Repeat the comparison of readings.
6. Record the thermometer readings, and the thermometer identification or location.
7. Install seals as appropriate on sensors and control boxes of digital thermometers.

Corrective Action: Do not run the Test if the mercury column has been split or capillary tube is broken. The thermometer should be returned to the factory for repair. When the indicating thermometer differs from the test thermometer by more than 0.25°C (0.5°F) and the airspace thermometer by more than 0.5°C (1°F), the indicating thermometer should be adjusted to agree with the test thermometer. Retest the thermometer after adjustment.

NOTE: If your unit has been sealed by Regulatory, that seal would need to be broken if an adjustment is required. Prior to breaking any seals, be sure to notify immediate Supervisor and Regulatory authority.

If cap is removed from electronic sensors, be sure to use caution near open water baths to prevent moisture damage to electronics.

The integral display on each of the sensors functions as the “Indicating Thermometer,” and should be positioned in the test bath for easy view.

Please note that displays and pens on the recording thermometer will also show movement – disregard for this test.

1. As described in Appendix I - TEST 1, the sensors are verified at specific points from the Pasteurization or Airspace temperatures. Refer to Appendix I – Test 1 for full details. Be sure to allow sufficient time for sensor to stabilize in bath prior to making adjustments.
2. If an adjustment is required, use a small straight blade screwdriver to turn the “SPAN” potentiometer located within the sensor housing. Adjust until the LCD display reads the desired value.

⊘ Do not make any adjustment to the potentiometer labeled “ZERO,” or the potentiometers located directly on the DISPLAY itself.

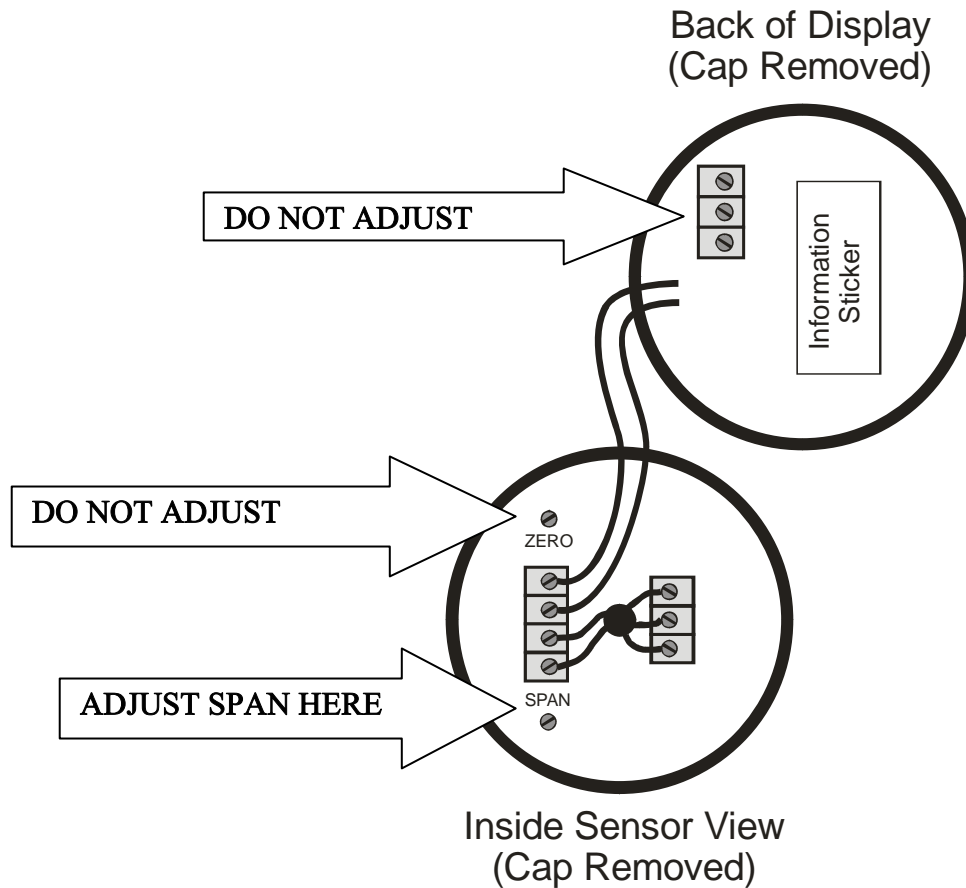

6.3. TEST 3 - Recording Thermometers – Time Accuracy

Test may be completed as described in the Pasteurized Milk Ordinance, with the following note:

This system utilizes a dual pen recorder. To perform this test, PEN 1 ONLY should be utilized, as it is the only pen that tracks the primary time arc on the chart.

For reference, text inserted from 2009 revision Pasteurized Milk Ordinance. Any special requirements that have been approved, but may differ from the standard PMO tests, immediately follow.

TEST 3 - RECORDING THERMOMETERS - TIME ACCURACY

Reference: Item 16p.(A), (B), (C) and (E)

Application: To all recording and recorder-controller thermometers used to record the time of pasteurization or aseptic processing.

Frequency: Upon installation; at least once each three (3) months thereafter; or whenever the seal of a programmable recorder-controller has been broken.

Criteria: The recorded time of pasteurization or aseptic processing shall not exceed the true elapsed time.

Apparatus:

1. A watch, graduated at intervals not to exceed one (1) minute, and accurate to within five (5) minutes in twenty-four (24) hours; and
2. A pair of dividers or any other suitable device for measuring short distances.

Method: Comparison of the recorded time over a period of not less than thirty (30) minutes with a watch of known accuracy. For recorders utilizing electric clocks, check the cycle on the faceplate of the clock with a known cycle and observe that the clock is in operating condition.

Procedure:

1. Determine if the chart is appropriate for the recording thermometer. Insure that the recording pen is aligned with the time arc of the chart at both the center and the outside edge.
 2. Inscribe a reference mark at the pen point on the recording chart and record the time.
 3. At the end of thirty (30) minutes by the watch, inscribe a second reference mark at the pen point position on the chart.
 4. Determine the distance between the two (2) reference marks and compare the distance with the time-scale divisions on the recording chart at the same temperature.
 5. For electric clocks, remove the faceplate and compare the cycle specification on the faceplate with the current cycle utilized.
- 276
6. Re-seal the regulatory controls as necessary; enter the findings on the chart and initial and record the results.

Corrective Action: If recorded time is incorrect, the clock should be adjusted or repaired.

6.4. TEST 4 - Recording Thermometers – Check Against Indicating Thermometer

NOTE: If your unit has been sealed by Regulatory, that seal would need to be broken if an adjustment is required. Prior to breaking any seals, be sure to notify immediate Supervisor and Regulatory authority.

For reference, text inserted from 2009 revision Pasteurized Milk Ordinance. Any special requirements that have been approved, but may differ from the standard PMO tests, immediately follow.

TEST 4 - RECORDING THERMOMETERS - CHECK AGAINST INDICATING THERMOMETERS

Reference: Item 16p.(A), (B), (C) and (E)

Application: To all recording and recorder-controller thermometers used to record milk or milk product temperatures during pasteurization or aseptic processing.

Frequency: Upon installation and at least once each three (3) months by the Regulatory Agency, or HACCP qualified industry person, acceptable to the Regulatory Agency, qualified under Item 16p(E)2; and daily by the milk plant operator.

Criteria: The recording thermometer and recorder-controller thermometer shall not read higher than the indicating thermometer.

Apparatus: No supplementary materials required.

Method: This Test requires only that the reading of the recording thermometer or the recorder controller thermometer be compared with the indicating thermometer at a time when both are exposed to milk or milk product at a stabilized pasteurization or aseptic processing temperature.

Procedure:

1. While the indicating and recording temperatures are stabilized at or above the minimum legal pasteurization or aseptic processing temperature, read the indicating thermometer.
2. Immediately record and identify on the recording thermometer chart, the observed indicating thermometer temperature reading and the time at which this comparison was made. This may be accomplished by inscribing a line intersecting the recorded temperature arc at the pen location or other methods acceptable to the Regulatory Agency.

NOTE: This Test shall be performed while the pasteurization operating temperatures are within the accurate range for the specific thermometers and charts used.

Corrective Action: If the mercury-actuated recording thermometer or recorder-controller thermometer reads higher than the indicating thermometer, the pen or temperature adjusting mechanism shall be adjusted by the operator. If the digital recording thermometer or recorder-controller thermometer reads higher than the indicating thermometer, the recording temperature should be adjusted to agree with the indicating thermometer. Retest the thermometer after adjustment.

NOTE: If you will be making an adjustment to the Recording Thermometer, and the HEALTH AUTHORITY SEAL is still in place on the CHART PLATE, be sure to follow the unlock procedure shown in section 4.2. If the unit has already had all menus enabled, use the following procedure to adjust temperature recording pen.

First verify that RECORDING PEN 1 matches the numeric value shown on the LEFT DISPLAY and that RECORDING PEN2 matches the numeric value shown on the RIGHT DISPLAY. Although the Recording Thermometer Displays are NOT a Regulatory reference, they are a benefit to the operator. As adjustment requires a broken seal, this is a good time to perform any adjustment that is needed. Refer to Section 7 for calibration details to match pen and display values.





This procedure only needs to be followed if an ADJUSTMENT to the Recording Thermometer is required.

Recorder adjustment is as follows:

1. Document the values displayed on the **RECORDING PENS**:

RECORDER PEN 1 (PRODUCT): _____

RECORDER PEN 2 (AIRSPACE): _____

2. Press the  key until "Prog" is displayed
3. Press the  key to enter the program mode (**SKIP TO STEP 10 FOR PEN 2**)
4. Pen 1 will be displayed in the left display. This display contains parameters for the recorded PRODUCT temperature. Press the  key to access the menu for "PEN 1."
5. Continue to press the  key until "iCor" is visible on the display, then press the  key **ONCE** to access the programmed value.
6. The setting should be changed to remove the difference between the display, as recorded in STEP 1 – PEN 1.

Example: Display of PRODUCT probe in bath = 145 deg F

Step 1 – Pen 1 = 144.5 deg F

Difference = 0.5 deg F "LOW"















"0.5 deg F" would be programmed into the "iCor" setting to add difference

Example: Display of PRODUCT probe in bath = 145 deg F

Step 1 – Pen 1 = 145.5 deg F

Difference = 0.5 deg F "HIGH"

"-0.5 deg F" would be programmed into the "iCor" setting to subtract difference

7. The display will change in accordance with the decimal position programmed for each channel. If whole degrees are programmed, the display will change 1 deg per step. If one decimal position is programmed, the display will change 0.1 deg per step. If you need to modify the decimal position, continue to press  until “dPOs” is visible on the display. Press the  key **ONCE** to access the programmed value. Use the   arrow keys to modify the setting to a “1,” then continue to press  until “iCor” is visible on the **LEFT** display.
8. Use the   arrow keys to modify the “iCor” setting with the value as determined in step “6.” If the “iCor” setting already contains a value, simply add the new value to the existing programmed value.
9. When complete, press the  key **ONCE**, then the  key **TWICE** to exit program menu.
10. For Pen 2 AIRSPACE temperature, press  until “Prog” is displayed in the LEFT display, then press the  key to enter the program mode – “PEN 1” will be displayed on the LEFT display.
11. Press the  key **ONCE** to advance to “PEN 2.”
12. Continue to press the  key until “iCor” is visible on the display, then press the  key **ONCE** to access the programmed value.
13. The setting should be changed to remove the difference between the display, as recorded in STEP 1 – PEN 2.

Example: Display of AIRSPACE probe in bath = 145 deg F

Step 1 – Pen 2 = 144.5 deg F

Difference = 0.5 deg F “LOW”









“0.5 deg F” would be programmed into the “iCor” setting to add difference

Example: Display of AIRSPACE probe in bath = 145 deg F



Step 1 – Pen 2 = 145.5 deg F

Difference = 0.5 deg F “HIGH”



“-0.5 deg F” would be programmed into the “iCor” setting to subtract difference

14. The display will change in accordance with the decimal position programmed for each channel. If whole degrees are programmed, the display will change 1 deg per step. If one decimal position is programmed, the display will change 0.1 deg per step. If you need to modify the decimal position, continue to press  until “dPOs” is visible on the display. Press the  key **ONCE** to access the programmed value. Use the   arrow keys to modify the setting to a “1,” then continue to press  until “iCor” is visible on the **RIGHT** display.
15. Use the   arrow keys to modify the “iCor” setting with the value as determined in step “13.” If the “iCor” setting already contains a value, simply add the new value to the existing programmed value.
16. When complete, press the  key **ONCE**, then the  key **TWICE** to exit program menu.
17. As recorder is now in “off” mode, use the following procedure to return to normal operation:

If you have a Recorder ONLY (Model “AJ-311”)

- Press  until “OPeR” is visible on the display
- Press  to return recorder to normal operation

Or – in the case of a Recorder Controller (Model “AJ-321 or AJ-322”)

- Press  until “Cntrl” is visible on the display
- Press  to return recorder to normal operation

6.5. TEST 15 - Electro Magnetic Interference

As of the release of this guide, VAT or Batch type pasteurization systems are not required to be subjected to this testing procedure. If you choose to test, be sure to follow procedure as documented in the Pasteurized Milk Ordinance. Be sure to always reference the current revision of the PMO for any future changes.

For reference, text inserted from 2009 revision Pasteurized Milk Ordinance. Any special requirements that have been approved, but may differ from the standard PMO tests, immediately follow.

TEST 15 - ELECTRO-MAGNETIC INTERFERENCE FROM HAND-HELD COMMUNICATION DEVICES

Application: To all electronic controls devices used to assure compliance with public health safeguards on continuous flow pasteurization and aseptic processing equipment that are installed in milk plants.

Frequency: Upon installation; any alteration of the electronic control devices; every three (3) months thereafter; and whenever the type or wattage of the hand-held communication device(s) used in that milk plant is changed. Once a hand-held communication device has been shown to cause a given electronic control device to react adversely, the electronic control device must be repaired and re-tested using the same type hand-held communication device. (Refer to the

NOTE: below.) If any electronic control device is altered or there is a change in the hand-held communication device(s) used, the electronic control device(s) would be required to be tested.
311

Criteria: The use of hand-held communication devices shall not have any adverse effect on the electronic control device's public health safeguards.

Apparatus: One (1) hand-held communication device representing each make and model used in the milk plant. The device must be operating at maximum output and be fully charged.

Method: By observing the actual effect of the hand-held communication device on an electronic control device, it can be determined if that hand-held communication device can be used near that equipment without compromising any of the electronic control device's public health safeguard.

Procedure:

1. Position the hand-held communication device 30.5 centimeters (12 inches) in front of the electronic control device where the public health safeguard(s) resides.
2. Place the hand-held communication device in the "send" mode for five (5) seconds and observe the effect on the electronic control device's public health safeguard(s). There should not be any adverse effect with the electronic control device. An adverse effect is any change that may adversely affect an electronic control device's public health safeguard(s).
3. If applicable, repeat the Test with the operator access door open
4. Repeat the above Test for each hand-held communication device identified in the Apparatus Section.
5. Repeat the Test for each electronic control device used to regulate a pasteurization or aseptic processing system's public health safeguard(s).

For Example: For the temperature set point, operate the pasteurization or aseptic processing equipment on water in diverted-flow in the "Product" mode, at a steady temperature within 3°C (5°F) of the lowest cut-in temperature. In this example, an adverse effect is defined as the forward-flow movement of the FDD or any artificial increase in temperature.

Corrective Action: Have the milk plant check for shielding, grounding and other installation concerns with the electronic control device and retest. Until a solution, acceptable to the Regulatory Agency, can be found that does not adversely affect the electronic control device's public health safeguard(s), the hand-held communication device cannot be used in the area of the electronic control device's public health safeguard(s).

NOTE: Continuous "Hand-Held Communication Device Free" or "Radio Free" zones, etc., are not acceptable permanent solutions to hand-held communication devices which cause adverse affects to an electronic control device's public health safeguards.

7. Troubleshooting

This section contains troubleshooting tips and procedures for conditions that may develop in the field. Prior to performing any adjustments, be sure to notify the proper Regulatory Authority in any case where Health Authority Seals are broken.

Refer to Section 4 in order to enable access to programming functions of the Recorder.

7.1. Recording Pen to Display Calibration







This procedure should be performed if the RECORDING PENS do not match the LED DISPLAYS by a difference greater than +/- 0.5 deg F.



















Keep in mind that the recorder displays are NOT the Regulatory reference. The use of the Recorder LED indicators during processing is for the convenience of the Operator only. All "Regulatory" readings should be taken directly from the recording pens themselves.













This procedure not only calibrates the displays, but also calibrates the recording pens.

NOTE: Be sure a chart is installed on the recorder, and that a clean area is present under the recording pens.

This section illustrates the procedure required to perform a pen calibration on the AJ-300. Before performing this calibration, the 'ECAL' menu must be set to "ON." Refer to section 4.2 for the complete option enable and disable procedure.

1. Press the  key until "Prog" is displayed
2. Press the  key to enter the program mode
3. Pen 1 will be displayed in the left display. This display contains parameters for the recorded PRODUCT temperature. Press the  key to access the menu
4. Press  until "iCor" is visible on the LEFT display window. This parameter will allow an input correction. This change affects both the display on the recorder as well as the recording pen.
5. Press the  key **ONCE** to access the programmed value. RECORD the value that was currently programmed for later reference.
6. Use the   arrow keys to modify the setting so that it reads "0".

7. Press  until “iCor” is visible on the display for Pen2. This value will show up in the RIGHT display window.
8. Press the  key **ONCE** to access the programmed value. RECORD the value that was currently programmed for later reference.
9. Use the   arrow keys to modify the setting so that it reads “0”.
10. When complete, press the  key **ONCE**, then the  key **TWICE** to exit program menu.
11. Press the  key until “CAL” is displayed
12. Press the  key to enter the calibration mode – display will change to CAL1
13. Press  until “CAL9” is visible on the display.
14. Press the  key, and hold, then the  key, then release both keys to enter the calibration mode.
15. “Pen1” will be visible on the display. If you wish to perform a calibration on Pen2, simply depress the  key once.
16. Press  key to begin the calibration process.
17. “P.dn” will be visible on the display, and the pen will move towards the inner ring on the chart. Once it achieves it’s home position, “PEnL” will be displayed.
18. If the felt tip pen is NOT directly on the inner chart ring, use the   arrow keys to make an adjustment. Sometimes it helps to tap the chart to eliminate any pen drag that is present.
19. When satisfied, press  key to move pen to the outside ring of the chart. “PuP” is displayed while the pen is moving, and “PEnH” is displayed once it has achieved the high position.
20. If the felt tip pen is NOT directly on the outer chart ring, use the   arrow keys to make an adjustment.

21. When satisfied, press  key to move pen to 50% chart span. “Pdn” is displayed while the pen is moving, and “PEN1” is displayed once it has achieved correct position.
22. Press the  arrow key twice to return to the main CAL menu, or the  key to move to “Pen 2”.
23. “Pen2” will be visible on the display.
24. Press  key to begin the calibration process.
25. “P.dn” will be visible on the display, and the pen will move towards the inner ring on the chart. Once it achieves it’s home position, “PENL” will be displayed.
26. If the felt tip pen is NOT directly on the inner chart ring, use the   arrow keys to make an adjustment. Sometimes it helps to tap the chart to eliminate any pen drag that is present.
27. When satisfied, press  key to move pen to the outside ring of the chart. “PuP” is displayed while the pen is moving, and “PENH” is displayed once it has achieved the high position.
28. If the felt tip pen is NOT directly on the outer chart ring, use the   arrow keys to make an adjustment.
29. When satisfied, press  key to move pen to 50% chart span. “Pdn” is displayed while the pen is moving, and “PEN2” is displayed once it has achieved correct position.
30. Press the  arrow key twice to return to the main CAL menu.
31. If you are done with all calibration, press the then the  key ONCE to exit all menus.



NOTE: It is recommended that the procedure be completed a second time for verification. If no additional changes are required, you may exit the procedure.

32. As the recorder is now in the “OFF” mode, use the following key sequence to return to normal operation:

If you have a Recorder ONLY (Model “AJ-311”)

- Press  until “OPER” is visible on the display
- Press  to return recorder to normal operation

Or – in the case of a Recorder Controller (Model “AJ-321 or AJ-322”)

- Press  until “Cntrl” is visible on the display
- Press  to return recorder to normal operation

You may now complete testing as described in the PMO procedures section. Instructions are provided to test probes and recorder for accuracy, and how to make trim adjustments if necessary.

NOTE: Entering the CAL menu again will wipe out the previous adjustments that were made. Only enter if you wish to start calibration procedure again.

7.2. Recording Thermometer and Indicating Thermometer Temperatures Differ

If a check of the Indicating Thermometer (Display on each sensor) to the Recording Thermometer (Chart Pen) indicates a discrepancy beyond what is allowed, troubleshoot as follows:

1. Remove both the AIRSPACE and PRODUCT sensors from the VAT.
2. Secure an ICE bath. This should consist of a small bucket filled with ice and water. Agitation must be present. Slowly bleeding an airline into the bucket will provide proper agitation.
3. Place BOTH sensors into the ice bath (immerse at least the first three inches), and let stabilize for approximately 10 minutes.
4. The display on each of the sensors, as well as the two recording pens should all indicate 32 deg F.. Note that readings may be +/- 0.5 degrees and still remain within specification.
5. If a problem exists with any of the individual temperature elements, you will quickly be able to isolate the ONE reading that differs the greatest from the others. THREE of the readings should be very close to each other.
6. If all readings remain close to each other, it is suggested that a hot water bath also be utilized. The temperature should be at or above the typical pasteurization temperature. As above, be sure to agitate the bath. Place BOTH sensors into the hot water bath (immerse at least the first three inches), and let stabilize for approximately 10 minutes.
7. **If AIRSPACE or PRODUCT INDICATING THERMOMETER (Sensor Display) is found to be out of tolerance beyond 5 deg F, the sensor must be replaced. If error is less than 5 deg F, calibration may be performed.**

NOTE – as Health Authority Seals must be broken, your local Regulatory Agency MUST be notified

8. Place both the AIRSPACE and PRODUCT sensors back into the agitated ICE bath. Let stabilize for approximately 10 minutes. Remove the seal and cap on the sensor to be adjusted.
9. Adjust ONLY the potentiometer labeled ZERO using a fine straight blade screwdriver. Turn adjustment until display indicates SAME temperature as other sensor.

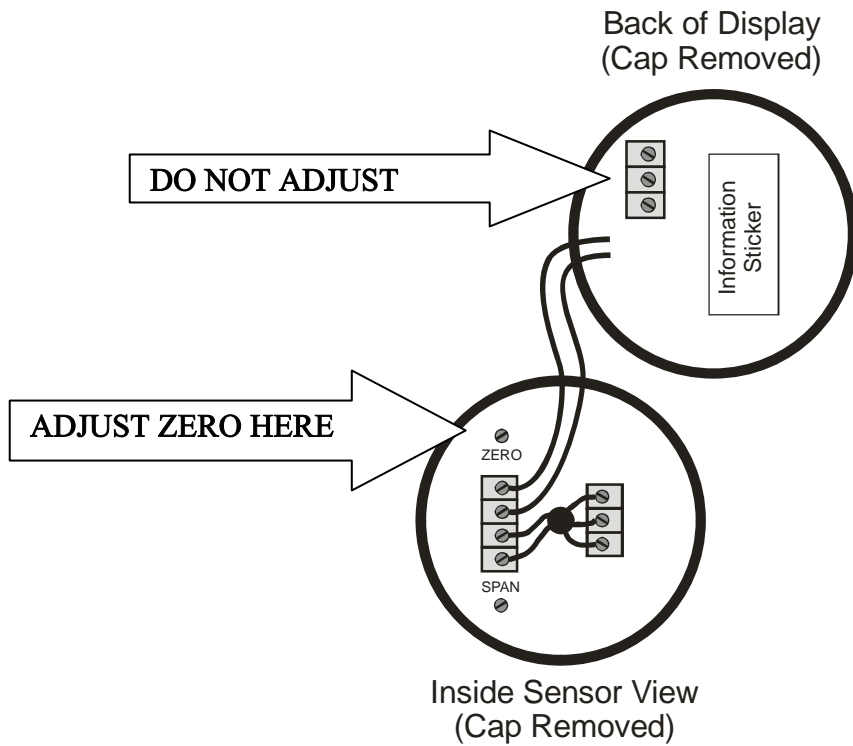



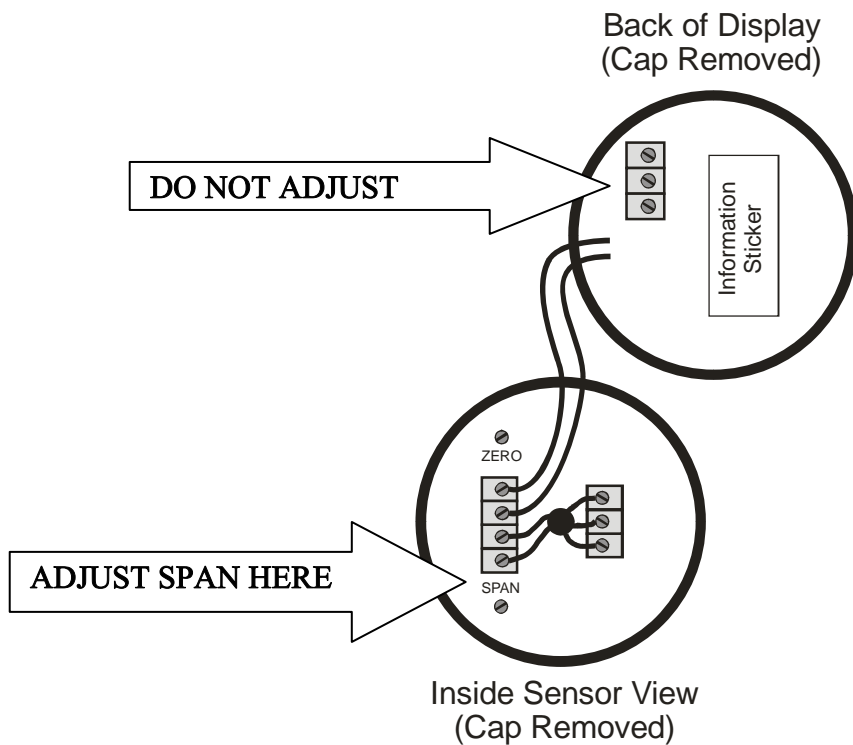

10. Place both sensors into the HOT water bath. Let stabilize for approximately 10 minutes. The temperature MUST remain steady. For a proper calibration, a regulated temperature bath is required.
11. Adjust ONLY the potentiometer labeled SPAN using a fine straight blade screwdriver. Turn adjustment until display indicates SAME temperature as other sensor.



12. Calibration is complete - Be sure to NOTIFY Regulatory if changes were made without their knowledge or presence.
13. **If AIRSPACE or PRODUCT RECORDING THERMOMETER (recording pen) is found to be out of tolerance beyond 5 deg F, the sensor must be replaced. If error is less than 5 deg F, calibration may be performed.**
14. Refer to Section 4.2 to be sure the PROGRAM menu has been enabled.
15. Place both sensors into the HOT water bath (immerse at least the first three inches). Let stabilize for approximately 10 minutes. The temperature MUST remain steady. For a proper calibration, a regulated temperature bath is required.
16. Document the values displayed on the Recording Pens and Indicating Thermometers:

RECORDER PEN 1 (PRODUCT): _____ and DISPLAY of PRODUCT SENSOR _____

RECORDER PEN 2 (AIRSPACE): _____ and DISPLAY of AIRSPACE SENSOR _____

17. Press the  key until "Prog" is displayed
18. Press the  key to enter the program mode (**SKIP TO STEP 25 FOR PEN 2**)
19. Pen 1 will be displayed in the left display. This display contains parameters for the recorded PRODUCT temperature. Press the  key to access the menu for "PEN 1."
20. Continue to press the  key until "iCor" is visible on the display, then press the  key **ONCE** to access the programmed value.
21. The setting should be changed to remove the difference between the RECORDING PEN, as recorded in STEP 16 – PEN 1, and the INDICATING THERMOMETER (Display on PRODUCT Sensor).

Example: Display of PRODUCT probe in bath = 145 deg F

Step 16 – Pen 1 = 144.5 deg F

Difference = 0.5 deg F "LOW"















"0.5 deg F" would be programmed into the "iCor" setting to add difference

Example: Display of PRODUCT probe in bath = 145 deg F

Step 16 – Pen 1 = 145.5 deg F

Difference = 0.5 deg F "HIGH"

"-0.5 deg F" would be programmed into the "iCor" setting to subtract difference

22. The display will change in accordance with the decimal position programmed for each channel. If whole degrees are programmed, the display will change 1 deg per step. If one decimal position is programmed, the display will change 0.1 deg per step. If you need to modify the decimal position, continue to press  until “dPOs” is visible on the display. Press the  key **ONCE** to access the programmed value. Use the   arrow keys to modify the setting to a “1,” then continue to press  until “iCor” is visible on the display.
23. Use the   arrow keys to modify the “iCor” setting with the value as determined earlier. If the “iCor” setting already contains a value, simply add the new value to the existing programmed value.
24. When complete, press the  key **ONCE**, then the  key **TWICE** to exit program menu.
25. For Pen 2 AIRSPACE temperature, press  until “Prog” is displayed in the LEFT display, then press the  key to enter the program mode – “PEN 1” will be displayed on the LEFT display.
26. Press the  key **ONCE** to advance to “PEN 2.”
27. Continue to press the  key until “iCor” is visible on the display, then press the  key **ONCE** to access the programmed value.
28. The setting should be changed to remove the difference between the RECORDING PEN, as recorded in STEP 16 – PEN 2, and the INDICATING THERMOMETER (Display on AIRSPACE Sensor).

Example: Display of AIRSPACE probe in bath = 145 deg F

Step 16 – Pen 2 = 144.5 deg F

Difference = 0.5 deg F “LOW”





“0.5 deg F” would be programmed into the “iCor” setting to add difference



Example: Display of AIRSPACE probe in bath = 145 deg F



Step 16 – Pen 2 = 145.5 deg F

Difference = 0.5 deg F “HIGH”

“-0.5 deg F” would be programmed into the “iCor” setting to subtract difference

29. The display will change in accordance with the decimal position programmed for each channel. If whole degrees are programmed, the display will change 1 deg per step. If one decimal position is programmed, the display will change 0.1 deg per step. If you need to modify the decimal position, continue to press  until “dPOs” is visible on the display. Press the  key **ONCE** to access the programmed value. Use the   arrow keys to modify the setting to a “1,” then continue to press  until “iCor” is visible on the display.

30. Use the   arrow keys to modify the “iCor” setting with the value as determined earlier. If the “iCor” setting already contains a value, simply add the new value to the existing programmed value.

31. When complete, press the  key **ONCE**, then the  key **TWICE** to exit program menu.

32. As recorder is now in “off” mode, use the following procedure to return to normal operation:

If you have a Recorder ONLY (Model “AJ-311”)

Press  until “OPER” is visible on the display

Press  to return recorder to normal operation

Or – in the case of a Recorder Controller (Model “AJ-321 or AJ-322”)

Press  until “Cntrl” is visible on the display

Press  to return recorder to normal operation

33. Be sure to NOTIFY Regulatory if changes were made without their knowledge or presence.

34. Refer to Section 4 in order to properly reset lock function of the system.

For questions, please contact:

Technical Services Department

Anderson Instrument Co., Inc.

156 Auriesville Rd.

Fultonville, NY 12072

Phone: 800-833-0081

Normal hours of operation are 8:00 am to 5:00 pm EST

24 hour / 7 day emergency phone support available

**Please dial above number, and follow voice prompts
(This service is provided at no charge)**

You may also directly contact the supplier of the complete system for more detailed questions on overall operation, as well as modifications not performed by Anderson.